

NETZSCH

Proven Excellence.

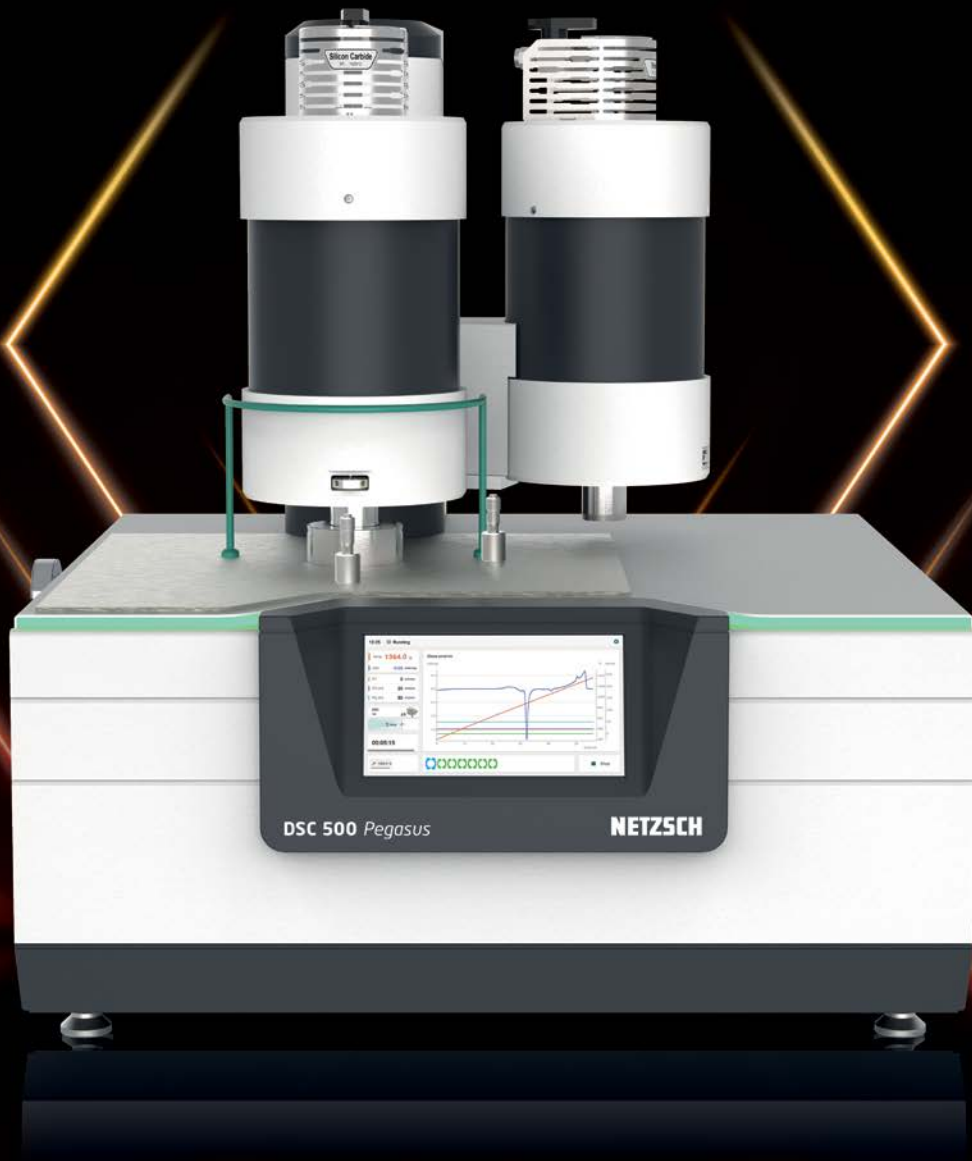

Differential Scanning Calorimetry – DSC 500 *Pegasus*®

Method, Technique, Applications

Analyzing & Testing

Outstanding Features

DSC 500 Pegasus®

At NETZSCH, we mastered the challenge of high-temperature DSC measurement years ago. Today, that same drive for perfection allows us to consistently offer the best solution on the market.



Modular Design for the Broadest of Temperature Ranges

A modular design facilitates the exchange of furnaces and sensors, making this instrument versatile for various applications. This system can operate over an extensive temperature range from -150°C to 2000°C, accommodating a wide array of thermal analysis needs.

Ideal Sensor Positioning for Accurate and Precise Results

The ability to precisely adjust sensor position in a high-performance heat-flux DSC provides exceptional accuracy for even demanding DSC applications like specific heat capacity (c_p) determination up to the highest temperatures.

The Right Sensor for Every Application

The instrument's ample flexibility is extended by an impressive assortment of sensors. The great variety of possible furnace/sensor combinations ensures optimal configuration for any application. The design provides user-friendly handling.



Elimination of Atmospheric Influences – Vacuum-Tight Design

The vacuum-tight design and meticulous control of gas flows allow precise handling of high-purity atmospheres with respect to various inert, oxidizing, reducing, and corrosive gases. Enthalpy changes and specific heat capacity (c_p) can be analyzed with an unequalled level of accuracy.

Color Touch Display and LED Status Bar

The color-coded LED light bar allows for remote monitoring of the instrument status. The integrated display simplifies measurement starts and streamlines pre-measurement checks without the need to log into a PC.

Efficient Time Management

The double hoist is designed to simultaneously connect two furnaces or one furnace with the Automatic Sample Changer (ASC), which handles up to 20 samples. This provides flexibility and high sample throughput for efficient time management.

Differential Scanning Calorimetry

Method

Differential scanning calorimetry (DSC) is one of the most frequently employed thermal analysis methods. It can be used to analyze nearly any energetic effect occurring in a solid or liquid during thermal treatment.

The DSC 500 *Pegasus*[®] systems operate according to the heat-flux principle. With this method, a sample and a reference are subjected to a controlled temperature program (heating, cooling or isothermal). The actual measured properties are the temperature of the sample and the temperature difference between sample and reference. From the raw data signals, the heat-flow difference between sample and reference can be determined.

The DSC 500 *Pegasus*[®] is in line with nearly every respective instrument and application standard, including: ISO 11357, ASTM E793, ASTM D3895, ASTM D3417, ASTM D3418, DIN 51004, and DIN 51007.

DSC Analysis Possibilities

- Determination of specific heat capacity
- Melting temperatures
- Transition enthalpies
- Phase transformations
- Phase diagrams (e.g., eutectics)
- Crystallization temperatures
- Degree of crystallinity
- Glass transition temperatures
- Thermal stability
- Decomposition effects
- Reaction kinetics
- Purity determination

DSC 500 *Pegasus*®

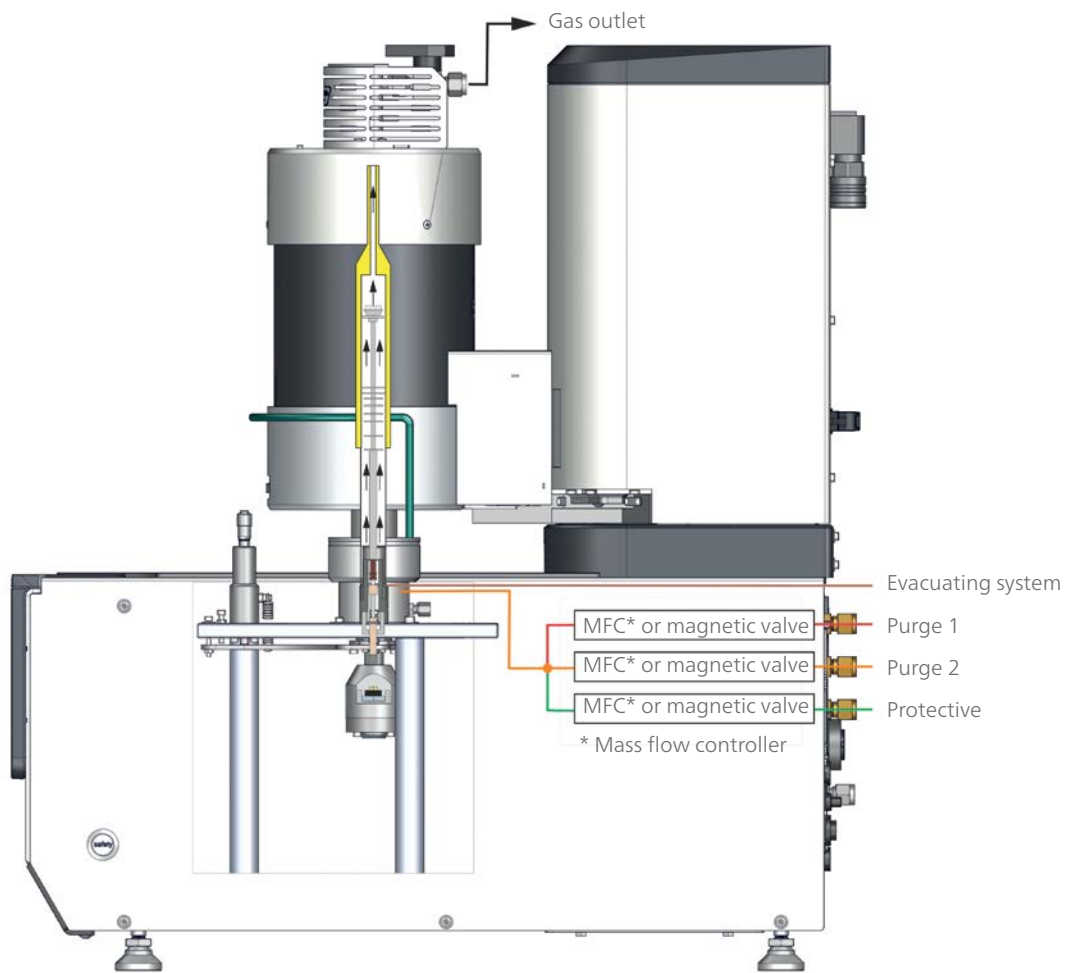

Modular Design – Interchangeable Furnace Systems

The DSC 500 *Pegasus*® systems can be equipped with a wide range of different furnaces accommodating different temperature and application ranges between -150°C and 2000°C. Silver and steel furnaces are available for the sub-ambient temperature range. Controlled cooling is realized with the liquid nitrogen cooling device or the Vortex tube. For higher temperature ranges, SiC, Pt, Rh and graphite furnaces are available. The platinum and the rhodium furnaces in combination with dedicated DSC sensors are specifically suited for determination of the specific heat capacity in the higher temperature range. User-friendly design allows for easy tube replacement by the operator, minimizing downtime.

Silicon Carbide Furnace – Day-to-Day Workhorse

The silicon carbide furnace, the robust workhorse of the DSC 500 *Pegasus*®, operates from ambient to 1600°C. Equipped with an aluminum oxide protective tube, it handles aggressive samples and evolving corrosive gases.

Perfect c_p Determination

The platinum and rhodium furnaces are designed with highest performance in mind. The precisely crafted metal-based heated systems exhibit excellent furnace performance and deliver precise and reliable results for demanding tasks, such as determining specific heat capacity even at temperatures above 700°C.

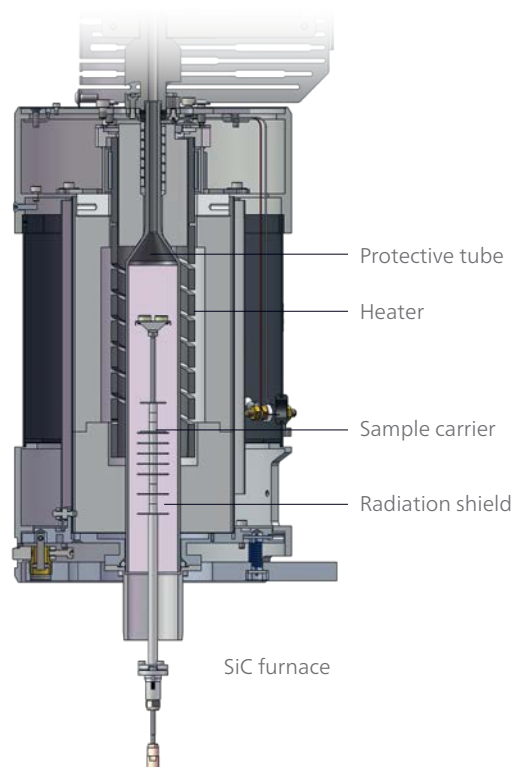

Furnace type	Temperature range ¹	Cooling system	Atmospheres
Silicon carbide	RT to 1600°C	Air	Inert, oxidizing, reducing, vacuum, corrosive
Platinum ²	RT to 1500°C	Air	Inert, oxidizing, reducing, vacuum, corrosive
Rhodium ²	RT to 1650°C	Air	Inert, oxidizing, reducing, vacuum, corrosive
Fast cooling	RT to 1600°C	Compressed air	Inert, oxidizing, reducing, vacuum, corrosive
Graphite	RT to 2000°C	Tap or chilled water ³ (or cooling thermostat)	Inert, oxidizing (with protective tube up to 1750°C), reducing
Copper (Humidity)	-150°C to 500°C	Liquid nitrogen/ Vortex ⁴	Inert, oxidizing, reducing, vacuum, humidity
Steel	-150°C to 1000°C	Liquid nitrogen/ Vortex ⁴	Inert, oxidizing, reducing, vacuum
Silver ²	-120°C to 675°C	Liquid nitrogen/ Vortex ⁴	Inert, oxidizing, reducing, vacuum

¹ Corresponds to maximum sample temperature range

² Optimally suited for c_p determination

³ Requires connection to cooling water

⁴ Alternative vortex cooling allows for start temperatures around 0°C

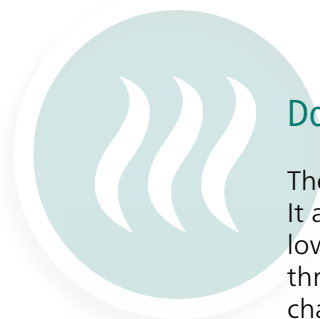

Double Hoist

The electrically driven double furnace hoist is a standard feature of the DSC 500 *Pegasus*®. It allows for simultaneous installation of two different furnaces to conduct, for example, low- and high-temperature tests with the same instrument. For an improved sample throughput, it is also possible to connect a single furnace along with the automatic sample changer (ASC) instead.



DSC 500 *Pegasus*® with graphite and SiC furnace

Various Sensors

The DSC 500 *Pegasus*[®] instruments are generally used to obtain accurate specific heat (c_p) measurements. However, the system allows for simple DTA measurements or conventional DSC tests as well. DTA sensors can be used for applications such as routine tests on aggressive sample substances. Various thermocouple types allow for optimum sensitivity and time constants in all temperature ranges. The sensors can be easily changed in less than a minute by the operator.



Interchangeable Sensors

Thermo-couple	Temperature range	Sensor types			Atmospheres				
		DTA	DSC	DSC- c_p	Inert	Oxidizing	Reducing ¹	Vacuum	Corrosive
E	-150°C to 700°C	✓	✓	✓	✓	✓ ⁴	✓	✓	
K	-160°C to 800°C	✓	✓	✓	✓	✓ ⁴	✓	✓	
P	-150°C to 1000°C		✓	✓	✓	✓	✓	✓	
S	RT to 1650°C	✓	✓	✓ ²	✓	✓	✓	✓	
S _{Protected}	RT to 1650°C	✓			✓	✓	✓	✓	
B	RT to 1750°C	✓	✓	✓ ³	✓		✓	✓	✓
W/Re	RT to 2000°C	✓			✓		✓	✓	

1 Upper temperature limit may deviate from the maximum temperature range of the sensor

2 Optimum accuracy to 1500°C

3 > 300°C to max. 1200°C

4 Up to 500°C



Unique Sensor Adjustment System

For optimizing the baseline, a micrometer adjustment system is integrated into the measurement part. This adjustment system allows for placement of the sensor at the optimum central position in the furnace. This creates a stable and reproducible baseline without any major adjustment efforts.



DTA sample carrier (protected version)



DTA sample carrier for temperatures up to 2000°C



DSC sample carrier



DSC c_p sample carrier with platinum crucibles



DSC c_p sample carrier for ASC operation (with OTS®)

A Wide Variety of Crucibles

What sets the DSC 500 *Pegasus*® systems apart is not only their flexibility in furnaces and sensors but also the huge variety of available crucibles. For the broad temperature range from -150°C to 2000°C, the crucible materials vary from metals (Al, Ag, Au, etc.) to ceramics (Al_2O_3 , MgO, ZrO_2 , Y_2O_3 , BN, etc.) to graphite. For inhomogeneous samples and those with low density, larger crucibles are available.

Should samples need to be shut off from the influence of the ambient atmosphere, or should gas emissions from the samples need to be contained, aluminum crucibles can be sealed shut, gas-tight, with a handy sealing press.

For measurements under increased pressures of up to 100 bar, reusable stainless steel and titanium autoclave crucibles handle the job.

Platinum Crucible with Liner and Shaping Tool

Our platinum crucible and Al_2O_3 liner combination improves the accuracy of high-temperature metal analysis in STA. The platinum provides exceptional thermal conductivity and stability, critical for accurate thermal analysis. A PtRh/Ceramic crucible system for measurements on metal melts or other reactive test materials is available with a removable liner.

Liners are available in thin-walled Al_2O_3 , MgO, and Y_2O_3 for measurements on metals at elevated temperatures. The alumina liner acts as an inert barrier, preventing interactions between reactive metals and the crucible. This preserves the integrity of the measurements, providing reliable data and reducing the risk of contamination – ideal for accurate thermal analysis of metals under challenging conditions.



DTA crucibles



DSC pans



PtRh pan and lid with removable ceramic liner and shaping tool

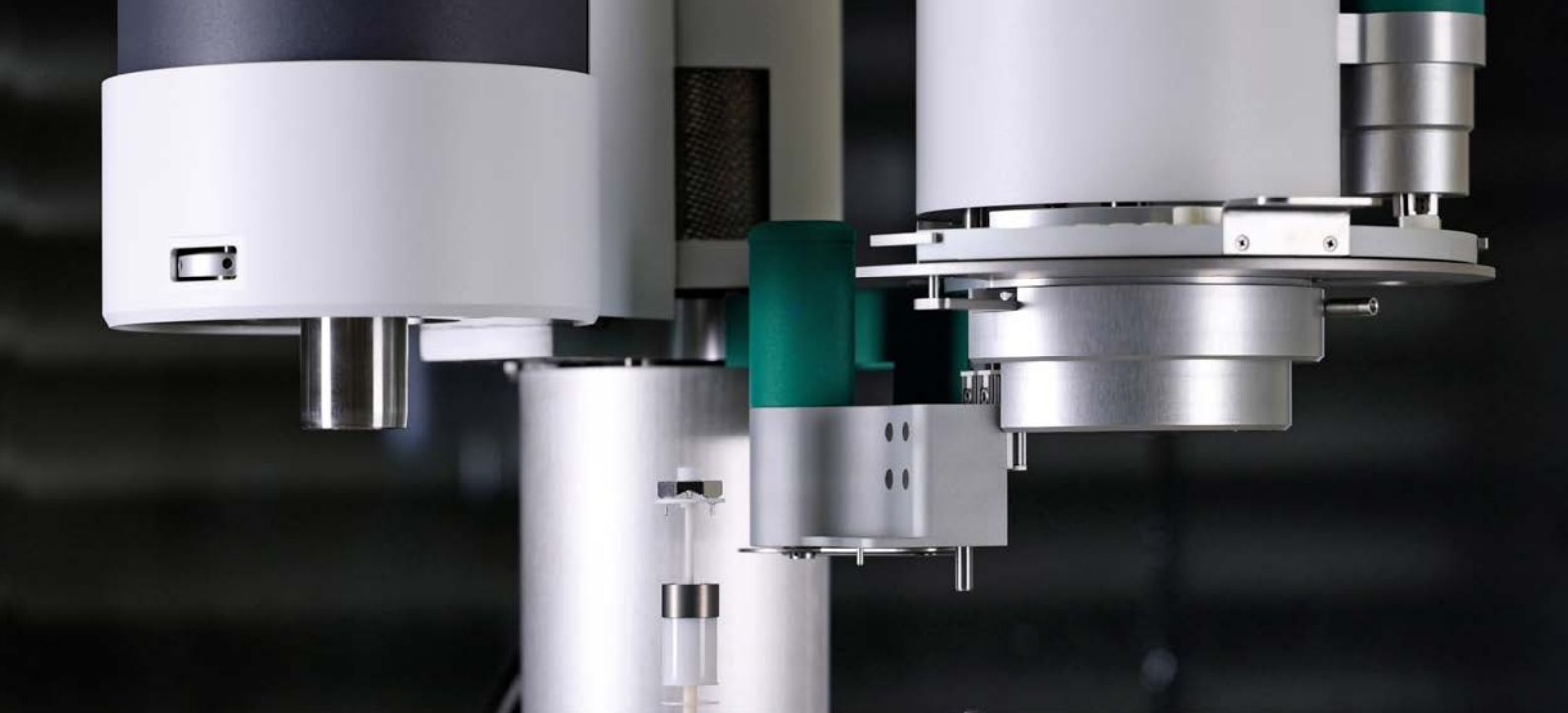

Automatic Sample Changer (ASC)

An automatic sample changer for up to 20 samples is optionally available. The sample changer is designed for optimum crucible placement and maximum throughput. Preprogramming allows measurements to be carried out during the night or weekend. The software can automatically carry out analyses using automatic or predefined evaluations. The ASC with its gripper and carousel can handle nearly any crucible type including specialties such as medium- and high-pressure crucibles.

“Remove Lid” Function of the ASC

For unstable samples – i.e., samples sensitive to oxygen or ambient room conditions while waiting their turn on the crucible magazine to be inserted into the sample compartment – a “remove lid” device can be ordered with the instrument. Closing the crucibles with a lid minimizes the risk that critical samples would evaporate or react with ambient humidity prior to the measurement.

Automatic Piercing Device

For highly unstable samples, an automatic piercing device attached to the gripper is optionally available; this pierces the lids of hermetically sealed aluminum pans shortly before the measurement starts.



Accessories to Create the Ideal Atmosphere

Optimal measurement conditions can be attained through the utilization of high vacuum, high purity, and reduced oxygen environments.

Atmosphere – Mass Flow Controllers

The DSC 500 *Pegasus*® comes standard-equipped with integrated metal-housed mass flow control systems for three different gases. Alternatively, the system can be equipped with frits for corrosive gas atmospheres or an optional fourth mass flow controller. Both MFC systems allow software-controlled gas switching and purge gas rates as well as recording of the flow rates in the software.

Vacuum-Tight Design – Optimum Atmosphere Control

The DSC 500 *Pegasus*® instrument stands out as a first-rate vacuum-tight high-temperature DSC. Virtually every component was specifically constructed with the requirements of high-vacuum and high-purity gas applications in mind. Various pump systems (from rotary or diaphragm to turbo molecular pumps) are available to evacuate the system down to 10^{-4} mbar*. Automatic evacuation is, of course, possible, as is backfilling with various kinds of purge gases.

* Actual achievable vacuum depends on the selected evacuation system

Oxygen Trap System for Measurement Under Oxygen Free Atmospheres

The OTS® (Oxygen Trap System) is a versatile and efficient solution designed for various applications, particularly in environments where managing oxygen levels is crucial. This system is engineered to effectively capture and remove oxygen from a given space, making it ideal for processes that require very low oxygen concentrations (< 1 ppm) to prevent oxidation or other chemical reactions.

The OTS® accessory can be used to drastically reduce the oxygen concentration at the sample to below 1 ppm.

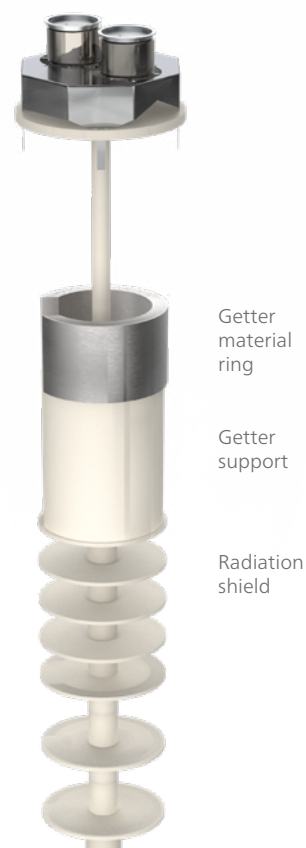

Special Solutions

Glove Box and Corrosion-Resistant Instrument Versions

Special DSC versions are available for use in a glove box and for measurements in corrosive atmospheres. This great flexibility allows the DSC 500 *Pegasus*® systems to be optimized and configured according to your needs – now and in the future.

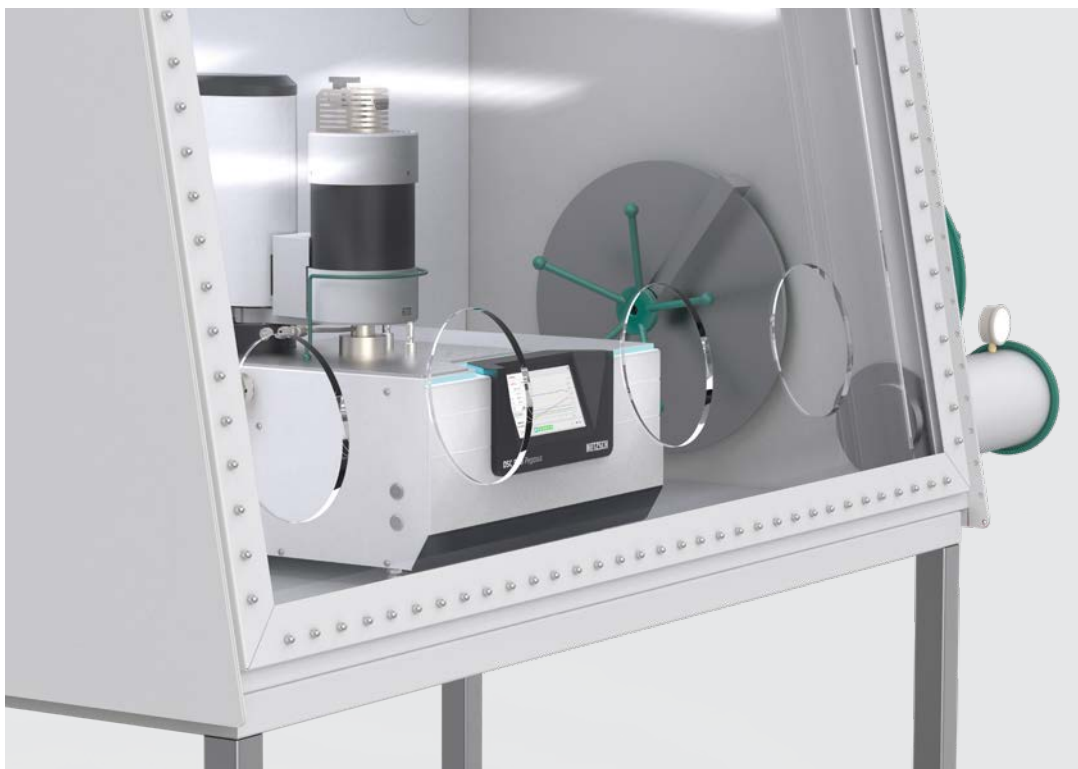

The DSC 500 *Pegasus*® in a glove box; gloves are not shown.



Proteus[®] Software

for the DSC 500 Pegasus[®]

Specific Heat Capacity c_p

From the DSC signal, the specific heat capacity $c_p(T)$ can be calculated based on ratio and stepwise methods that are in accordance with ASTM E1269, DIN 51007 or DIN 11357-4, but also directly and automatically from the DSC heat flow in accordance with DIN 51007. The $c_p(T)$ results can be shown together with uncertainty margin curves.

Temperature-modulated DSC

In TM-DSC, the underlying linear heating rate is superimposed by a sinusoidal temperature variation. The benefit of this procedure is the ability to separate overlapping DSC effects by calculating the reversing and the non-reversing signals. The reversing heat flow is related to the changes in specific heat capacity (\rightarrow glass transition) while the non-reversing heat flow corresponds to time-dependent phenomena such as curing, dehydration and relaxation.

Peak Separation

For experimental curves exhibiting overlapping effects (TGA, DSC, MS, FT-IR), our software allows for the separation of such peaks. It facilitates the presentation of experimental data as a sum of individual peaks and enables analysis of each peak separately.

2D Temperature Calibration

This advanced temperature calibration, which conforms to international standards, is not only temperature-dependent, but also heating-rate-dependent. This software option is especially beneficial for temperature accuracy when different heating rates are used in the same measurement.

Kinetics Neo – Process Optimization by Prediction

Kinetics Neo creates kinetic models of chemical reactions and physical processes based on a series of measurements under different temperature conditions and heating rates. With Kinetics Neo, processes can be simulated by the user to predict the behavior of chemical systems under different conditions. This paves the way for process optimization.

Software Features

- | | |
|---|--|
| ■ | <i>AutoEvaluation</i> |
| ■ | <i>BeFlat^{®*}</i> |
| ■ | OIT (Oxidation Induction Time/Temperature) |
| ■ | Report Generator |
| ■ | Eco Mode |
| □ | <i>Identify</i> |
| □ | <i>Proteus[®] Search Engine</i> |
| □ | <i>Peak Separation</i> |
| □ | Specific Heat Capacity (c_p) |
| □ | <i>2D Temperature Calibration</i> |
| □ | Temperature Modulation (TM-DSC) |
| □ | Purity |
| □ | <i>Proteus[®] Protect</i> |
| □ | Kinetics Neo |
| □ | Termica Neo ^{**} |
| □ | LIMS |
| □ | LabV [®] |

- included * included when MFC is selected
□ optional ** requires Kinetics Neo

More features on request.

Proteus® Search Engine – Smart Data Management

When working with measurement and evaluation data for different materials and different measurement setups, it is enormously helpful to be able to directly access and sort data by certain criteria. *Proteus® Search Engine* automatically synchronizes the data shown with pre-defined directories and filters it in a matter of seconds. Previews of measurement curves or analysis status are available with just one click.

Users are able to create individual searches, for example “MyMetals”, and switch easily between different existing searches. This makes *Proteus® Search Engine* a very powerful data management tool.



Advantages of Proteus® Search Engine

- Efficient data management
- Directly access and sort data by criteria
- Quickly get measurement and analysis previews without opening files
- Retrieve data quickly and easily
- Search, e.g., by instrument name, method, operator, file and signal type, date, measurement conditions or evaluated effects

Proteus® Search Engine and LabV®



LabV® – Taking Advantage of the Digital Lab

NETZSCH instruments are compatible with the LabV® data management platform, a user-friendly software solution that automates data collection, regardless of method or device, and provides a centralized view for organizing, analyzing, and exploring your data. LabV®'s AI-powered digital assistant simplifies data analysis, allowing labs to access valuable insights with next to no effort. It uses natural language processing, similar to ChatGPT, making it easy for labs to create visual output, spot trends, and uncover complex correlations with straightforward commands.

Advantages of LabV®

- **Laboratory Automation**
Streamline your testing process and connect all your testing devices
- **Cloud Solution**
- **Improved Quality Control**
Improve the quality of your materials with insights, intelligent alerts and intuitive data management
- **Faster Development**
Leverage your lab data to accelerate material development



Measurement Update in Passing – LED Status Bar

The DSC 500 *Pegasus*® features an LED light bar that allows the status of your instrument to be checked as you walk by, with different colors representing different statuses. It is reassuring to see from afar, without having to log into your PC, that your measurement is running smoothly and to be able to read instrument status notifications such as:

- Instrument is ready
- Measurement is running
- Measurement progress
- Heating/cooling to setpoint
- User interaction needed
- A problem occurred

Improving Your Productivity and Workflow Using the User Interface

The integrated color display allows you to start a measurement that was previously prepared in the NETZSCH *Proteus*® software. Just touch the prepared measurement button on the display and you will be informed about the setup of the measurement. This moves the final check before you start a new measurement directly onto the instrument.

The color touch display offers the ability to:

- Start measurements by the touch of a finger
- Check recently finished measurements
- See the progress of your measurement and time remaining
- Check current temperature
- Check and change gas flow and gas types
- Start and check *AutoVac* cycles

The DSC 500 *Pegasus*[®] – Placing Instrument Control and Information Directly Onto the Instrument



Supervising your measurement made easy: monitor measurement progress, control and configure setpoint and gas flow

AutoEvaluation: Availability of Objective Results after Measurements

If *AutoEvaluation* has been activated in the measurement setup, the measurement data will be evaluated immediately and objectively within the blink of an eye. An evaluation of the measurement curve will be available in an analysis window after the measurement has finished. The original plot will still be accessible.

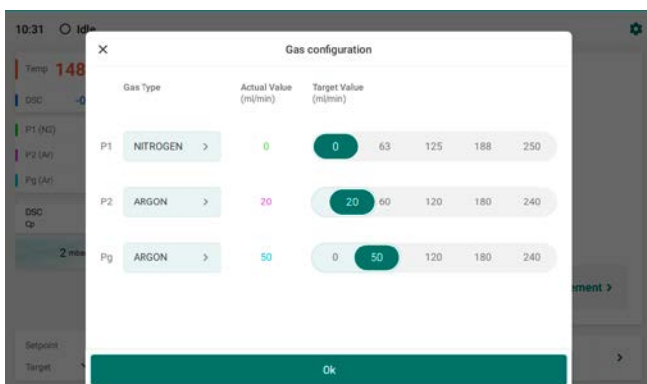

Gas configuration lets you change the gas flow.

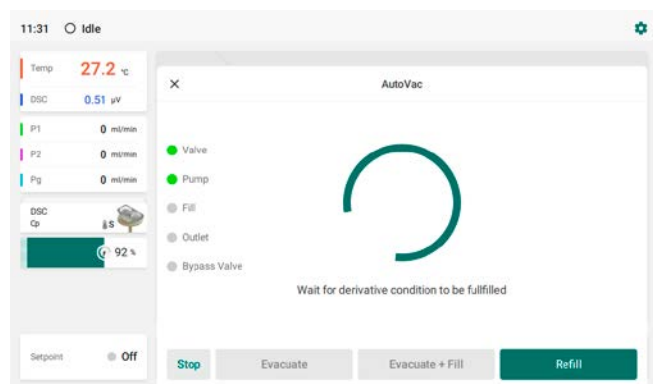

Information about the *AutoVac* process is clearly displayed on the instrument

Performance and Applications

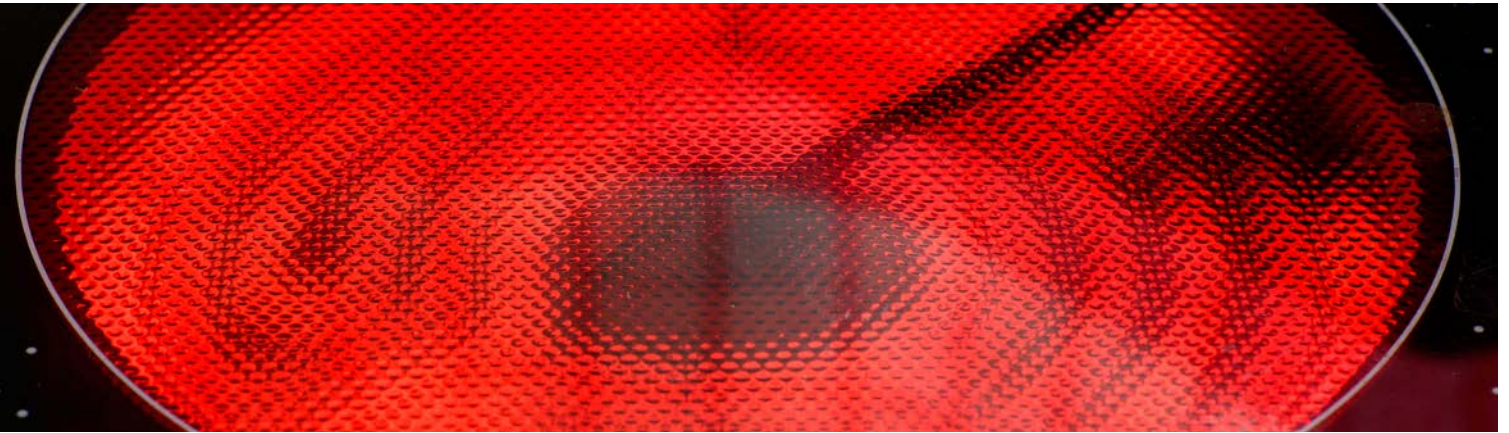

Lithium-Aluminum-Silicate Glass Ceramic

The DSC measurement here from RT up to 1500°C provides insights into the thermal behavior of a lithium-aluminum-silicate glass ceramic (LAS). Key transitions include the glass transition at 716.0°C, indicated by a small endothermic step in the baseline. This effect represents the amorphous parts. When sufficient thermal energy is applied, the metastable glassy phase begins to return to the lower-energy, crystalline state, which can be observed by the sharp exothermic crystallization peak at 884.4°C. The large endothermic peak between 1252.4°C and 1306.8°C corresponds to melting of these crystalline parts. Glass transition and crystallization during heating influence the material's properties and can be tailored by controlling the glass composition and the heat treatment/crystallization. Above melting, the flat baseline signifies no material decomposition,

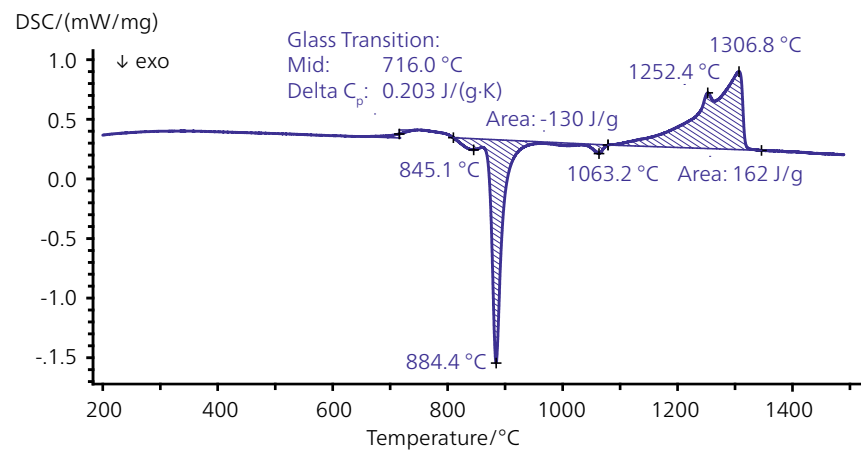

DSC measurement on LAS:
Sample mass: 50.09 mg; heating rate: 20 K/min; atmosphere: argon;
crucible with pierced lid: Pt/Rh.

another indication of the high thermal stability of the material. This information and the possibility of investigating the cooling behavior (not shown here) make the DSC an indispensable tool for evaluating material properties in high-performance glass-ceramic applications.

Au-Pt Alloy for Dental Restoration

This DSC curve illustrates the thermal profile of a gold-platinum alloy frequently used in dental restorations, providing key insights into its behavior under heating and cooling cycles. The heating curve (in red) reveals an onset at 1030.4°C and an endset at 1139.9°C, with an enthalpy of 50.17 J/g, while the cooling curve (in blue) indicates an onset at 1126°C and an endset at 1007.0°C, with an enthalpy of -54.76 J/g. These thermal properties are critical for assessing the alloy's melting and solidification behavior – an essential aspect of the manufacturing process for high-quality, long-lasting dental restorations.

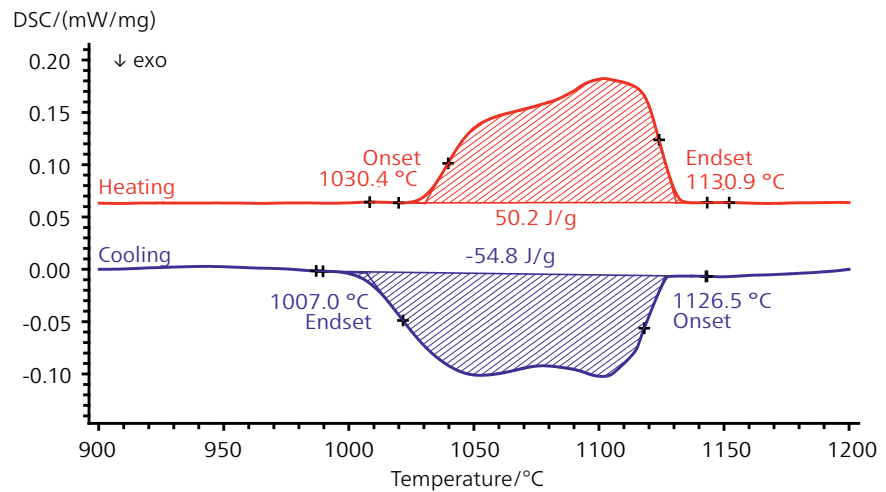

DSC measurement of an Au-Pt alloy:
Sample mass: 74.224 mg; heating rate: 10 K/min; atmosphere: argon; crucible with pierced lid: Al₂O₃.

Nickel-Based Superalloy

The presented DSC curve provides insight into the thermal characteristics of a nickel-based superalloy, a material renowned for its durability in extreme environments such as gas turbines and jet engines. In the heating curve (red), three significant endothermic peaks are observed at approximately 1244.4°C, 1347.8°C and 1362.1°C, indicating phase transformations including the melting of the sample. The heat absorbed in these transitions is quantified as 25.3 J/g and 204.6 J/g, respectively. The cooling curve (blue) shows corresponding exothermic events with peaks around 1169.9°C, 1237.3°C, and 1344.9°C with a total release of -226.4 J/g. These events represent the complex crystallization behavior due to the different phases present within the alloy system.

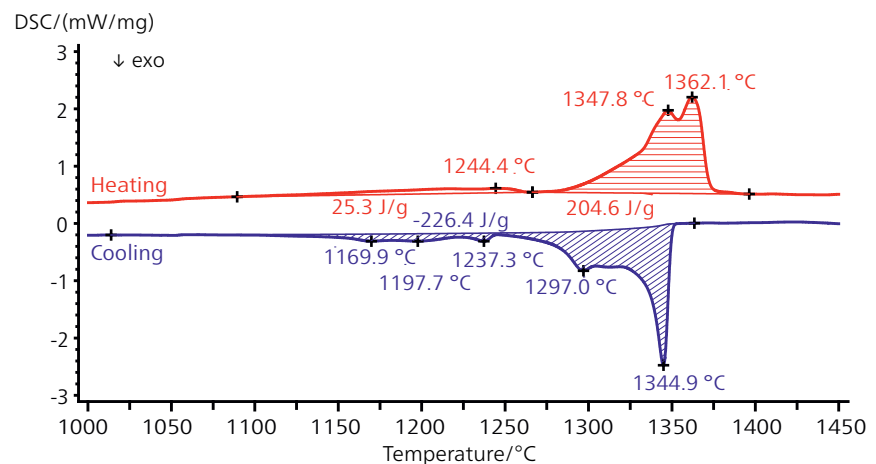

DSC curves of nickel-based superalloy:
Sample mass: 31.496 mg; heating rate: 20 K/min; atmosphere: argon; crucible with pierced lid: Pt/Rh and Al₂O₃ liner.

Smart Software Supporting Measurement Evaluation

AutoEvaluation – Fast and Objective Results Right After a Measurement

AutoEvaluation is the industry's first self-operating evaluation system for DSC analyses. It automatically evaluates endo- or exothermic reactions and identifies peak temperatures without user input. By providing immediate, post-measurement display of evaluated curves, *AutoEvaluation* enhances both the objectivity and efficiency of the analysis process. Users can customize detection settings and displayed results, making it an ideal solution for both beginners and experts seeking streamlined, reliable data interpretation.

In this example, the *AutoEvaluation* function is applied to the analysis of metal melting peaks. Without any manual input, *AutoEvaluation* identifies key thermal events occurring in various metal measurements. For each metal, *AutoEvaluation* autonomously detects the onset temperature and calculates the corresponding enthalpy area (J/g), providing accurate results without further user input.

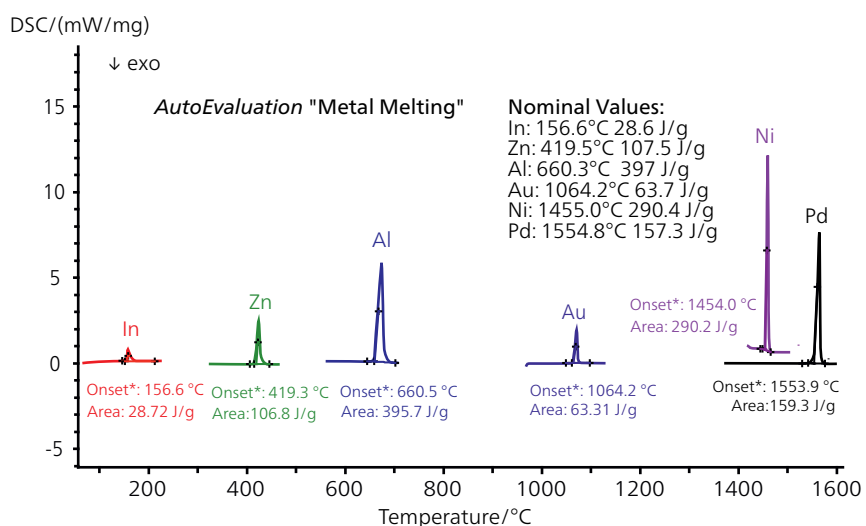

Various DSC measurements on metal calibration standards, automatically evaluated using the *AutoEvaluation* function "Metal Melting".



Quality Control of Specific Heat Capacity (C_p) Measurements Using *Identify*

Identify is a powerful database tool in thermal analysis designed for material identification and quality control. With over 1300 entries, it covers a diverse range of materials, including polymers, pharmaceuticals, ceramics, metals, and more.

Identify supports various signal types, such as DSC, DSC- c_p , TGA, TGA-c-DTA®, STA, DIL/TMA and DMA, allowing users to expand the database with their custom data. This extensive database helps users interpret results, plan experiments, and ensure quality.

In the presented example, a specific heat capacity measurement (black curve) is compared with a quality control class from the database, revealing a close match with the highlighted reference curve. This intuitive approach provides a quick and effective quality check, enabling users to validate experimental data with confidence. The software simplifies the assessment by delivering a clear “PASS” result, streamlining quality control processes and ensuring data reliability with the use of trusted reference standards.

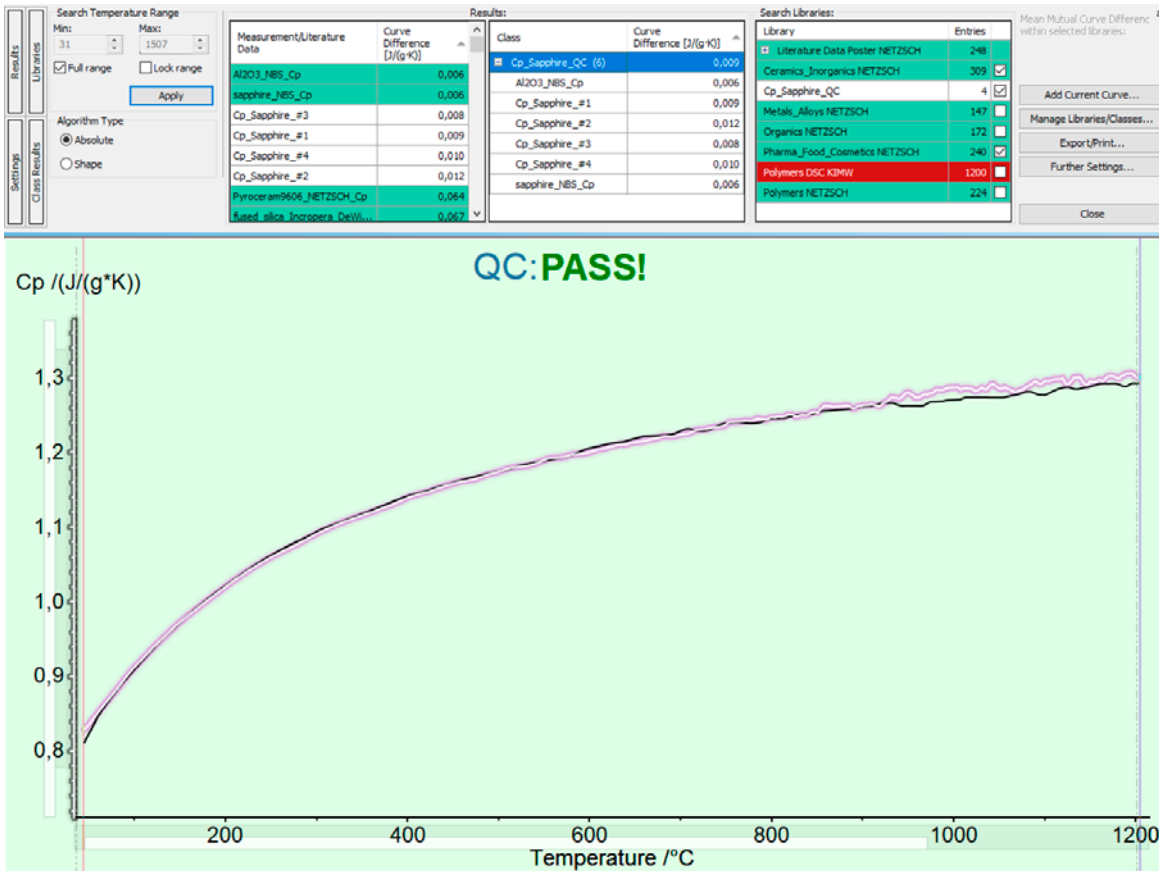

Identify-comparison of the specific heat capacity

DSC 500 Pegasus®

Temperature range	-150°C to 2000°C
Furnaces	Standard and special furnaces
Heating/cooling rate	0.001 K/min to 50 K/min (depending on furnace type)
Furnace hoist	Motorized double hoist for two furnaces or one furnace combined with the ASC
Sensor types	DTA, DSC, DSC- c_p (quick and safe interchange)
Temperature accuracy	1 K
Enthalpy accuracy	1 to 3%
c_p measuring range ¹	Up to 5 J/(g*K)
c_p accuracy ¹	1 to 3.5%
Gas atmospheres	Inert, oxidizing, reducing, corrosive, vacuum
Vacuum-tightness ²	10 ⁻⁴ mbar (10 ⁻² Pa)
Gas control	3 integrated mass flow controllers (MFCs), flow rate 0-250 ml/min, plus 4 th optional
Automatic sample changer (ASC)	20 samples, removable carousel (optional)
Automatic evacuation	Software-controlled
Coupling to evolved gas analyzers	FT-IR, MS, FT-IR-MS, GC-MS, GC-MS-FT-IR, PulseTA® (optional)

¹ c_p , specific heat capacity

² Actual achievable vacuum depends on the selected evacuation system

Technical Specifications



Proven Excellence in Lab & Services

NETZSCH Analyzing & Testing offers a broad spectrum of services for your thermal analysis instruments – from the basics to complete value retention for your instrument, including various training programs and application support.

More information can be found on our website.

The owner-managed NETZSCH Group is a leading global technology company specializing in mechanical, plant and instrument engineering.

Under the management of Erich NETZSCH B.V. & Co. Holding KG, the company consists of the three business units Analyzing & Testing, Grinding & Dispersing and Pumps & Systems, which are geared towards specific industries and products. A worldwide sales and service network has guaranteed customer proximity and competent service since 1873.

When it comes to Thermal Analysis, Calorimetry (adiabatic & reaction), the determination of Thermophysical Properties, Rheology and Fire Testing, NETZSCH has it covered. Our 60 years of applications experience, broad state-of-the-art product line and comprehensive service offerings ensure that our solutions will not only meet your every requirement but also exceed your every expectation.

Proven Excellence. ■

NETZSCH-Gerätebau GmbH
Wittelsbacherstraße 42
95100 Selb, Germany
Tel.: +49 9287 881-0
Fax: +49 9287 881-505
at@netzsch.com
<https://analyzing-testing.netzsch.com>



NETZSCH®

www.netzsch.com